



Compacto
Express
protección solar

protección solar

compacto pvc enrasado
catálogo

www.compactoexpress.com

Dimensiones disponibles (mm)

155 X 155	185 x 185	200 x 200	225 x 225
-----------	-----------	-----------	-----------

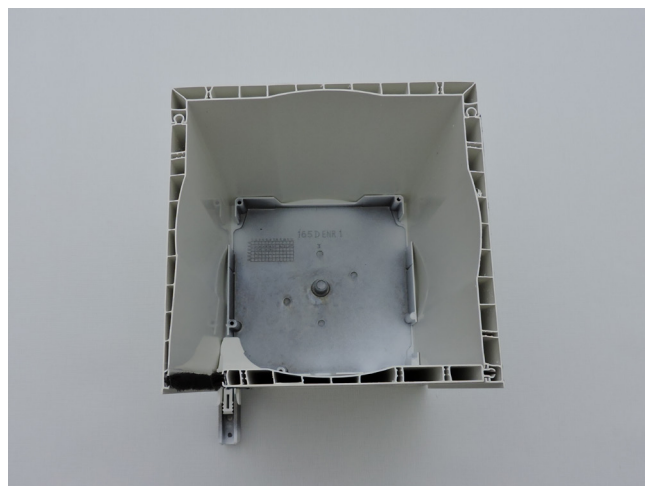

Datos ensayos técnicos

	155 x 155	185 x 185	200 x 200	225 x 225
Aislamiento acústico	Ra= 28dBa	Ra= 30dBa	Ra= 35dBa	
Transmisión térmica	U= 2.1 W/m2K	U= 2.2 W/m2K	U= 2.2 W/m2K	U= 2.0 W/m2K
Permeabilidad al aire	Clase 3	Clase 3	Clase 3	
Estanqueidad al agua	Clase E ₃₀₀₀	Clase E ₂₂₅₀	Clase E ₁₃₅₀	
Resistencia carga del viento	P3= 3000pa	P3= 3000pa	P3= 1800pa	

Tabla de enrollamientos

modelo de lama	Modelo cajón													
	155 x 155			185 x 185			200 x 200				225 x 225			
	Ø Eje													
	Ø 42	Ø 50	Ø 60	Ø 42	Ø 50	Ø 60	Ø 42	Ø 50	Ø 60	Ø 70	Ø 42	Ø 50	Ø 60	Ø 70
C-45	1750	1650	1200	2300	2200	2100	2750	2650	2500	2400	3400	3300	3200	3100
C-56	×	×	700	×	×	1400	×	×	1700	1600	×	×	2600	2500
CE-40	×	1050	950	×	1850	1750	×	1900	1800	1700	×	2750	2650	2550
ATB-45	×	1100	1000	×	1800	1700	×	2200	2100	2000	×	2750	2650	2550
ATB-39	×	1350	1250	×	2300	2200	×	2850	2750	2650	×	3200	3100	3000
CP-39	1650	1650	1200	2300	2200	2100	2750	2650	2500	2400	3400	3300	3200	3100

Modelos de lama compatibles

Modelo	Laminado		Aluminio extrusionado			Pvc
	C-45	C-56	CE-40	ATB-45	ATB-39	CP-39
						
Peso m ²	3.5 Kg	3.5 Kg	10 Kg	11 Kg	11 Kg	4.5 Kg
Ancho máximo	2500 mm	3500 mm	3000 mm	3000 mm	2500 mm	1400 mm
Alto máximo	3000 mm	4000 mm	4000 mm	3500 mm	3500 mm	2400 mm
Superficie máxima	6 m ²	8 m ²	8 m ²	8 m ²	7 m ²	3.5 m ²
Terminales compatibles	TER-GOM TER-FL68	TER-GOM TER-FL68	TER-GOM TER-FL68	TER-ATB	TER-FL68	ER-GOM / TER- FL68
Ø Eje mínimo	Ø 42 mm	Ø 60 mm	Ø 60 mm	Ø60 mm	Ø 60 mm	Ø42 mm

Resistencia al viento (medidas hueco luz)

modelo	120 x 200	150 x 200	210 x 250	2400 x 2500	2500 x 2500	2700 x 2500	3000 x 2500	3500 x 2500
C-45	6	5	3	2	1	1	0	0
C-56	6	6	4	3	3	3	2	1
CE-40	6	6	6	6	5	4	4	3
ATB-45	6	6	6	6	5	5	5	3
ATB-39	6	6	6	6	5	5	5	3
CP-39	3	1	0	0	0	0	0	0

Equivalencias

Km / hora	110	90	70	55	45	35	<35
Mts / seg	30.55	25.00	19.44	15.28	12.50	9.72	<9.72
Clase	6	5	4	3	2	1	0

Cálculos realizados según norma EN 13659

Color y modelo disponibles

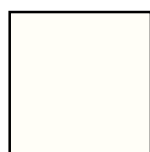

Blanco

C-45 / C-56 (pintura liquida)
CE-40 / ATB-45 / ATB-39 (pintura epoxi)
CP-39 (coloreado en masa)



Plata

C-45 / C-56 (pintura liquida)
CE-40 / ATB-45 / ATB-39 (anodizado)
CP-39 (coloreado en masa)



Bronce

C-45 / C-56 (pintura liquida)
CE-40 / ATB-45 / ATB-39 (anodizado)



Ral 1015 (marfil)

C-45 / C-56 (pintura liquida)
CE-40 / ATB-45 / ATB-39 (pintura epoxi)
CP-39 (coloreado en masa)



Ral 3005

C-45 / C-56 (pintura liquida)
CE-40 / ATB-45 / ATB-39 (pintura epoxi)



Ral 6005

C-45 / C-56 (pintura liquida)
CE-40 / ATB-45 / ATB-39 (pintura epoxi)



Ral 6009

C-45 / C-56 (pintura liquida)
CE-40 / ATB-45 / ATB-39 (pintura epoxi)



Ral 7011

C-45 / C-56 (pintura liquida)
CE-40 / ATB-45 / ATB-39 (pintura epoxi)



Ral 8014

C-45 / C-56 (pintura liquida)
CE-40 / ATB-45 / ATB-39 (pintura epoxi)



Ral 9075

C-45 / C-56 (pintura liquida)
CE-40 / ATB-45 / ATB-39 (pintura epoxi)



Negro 9020

C-45 / C-56 (pintura liquida)
CE-40 / ATB-45 / ATB-39 (pintura epoxi)



Madera claro

C-45 / C-56 (pintura liquida)
CE-40 / ATB-45 / ATB-39 (pintura epoxi)

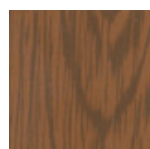

Madera oscuro

C-45 / C-56 (pintura liquida)
CE-40 / ATB-45 / ATB-39 (pintura epoxi)

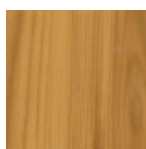

Nogal claro

C-45 / C-56 (pintura liquida)
CE-40 / ATB-45 / ATB-39 (pintura epoxi)

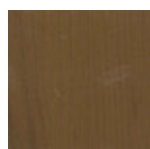

Nogal oscuro

C-45 / C-56 (pintura liquida)
CE-40 / ATB-45 / ATB-39 (pintura epoxi)

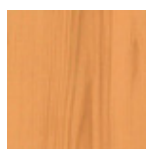

Pino nudos

C-45 / C-56 (pintura liquida)
CE-40 / ATB-45 / ATB-39 (pintura epoxi)

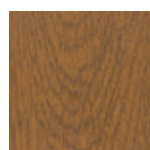

Roble golden

C-45 / C-56 (pintura liquida)
CE-40 / ATB-45 / ATB-39 (pintura epoxi)

Debido a los diferentes ajustes de pantalla o impresión la tonalidad de los colores puede variar, por lo tanto las muestras de color expuestas SOLAMENTE SE DEBEN TOMAR COMO ORIENTATIVAS.

□ Para cualquier otro acabado de color. Solicite disponibilidad y precio.

Acabados normalizados y medidas disponibles

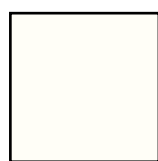

Blanco
155 / 185 / 200 / 225

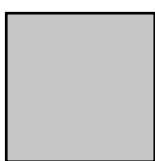

Plata
155 / 185 / 200



Bronce
155 / 185 / 200

Acabados RAL estándar y medidas disponibles

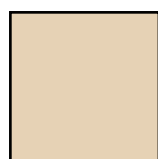

Ral 1015 (marfil)
155 / 185 / 200



Ral 3005
155 / 185 / 200



Ral 6005
155 / 185 / 200



Ral 6009
155 / 185 / 200



Ral 7011
155 / 185 / 200



Ral 8014
155 / 185 / 200



Ral 9075
155 / 185 / 200



Negro 9020
155 / 185 / 200

Acabados imitación madera y medidas disponibles



Madera claro
155 / 185 / 200

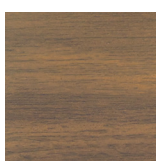

Madera oscuro
155 / 185 / 200

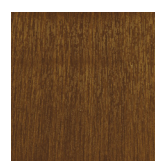

Roble oscuro
155 / 185 / 200



Nigra
155 / 185 / 200



Pino nudos
155 / 185 / 200

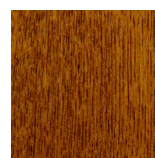

Roble golden
155 / 185 / 200

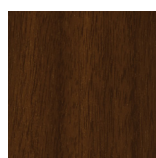

Moca
155 / 185 / 200

Debido a los diferentes ajustes de pantalla o impresión la tonalidad de los colores puede variar, por lo tanto las muestras de color expuestas SOLAMENTE SE DEBEN TOMAR COMO ORIENTATIVAS.

□ Para cualquier otro acabado de color o medida de cajón. Solicite disponibilidad y precio.



Cajones

CAJÓN 155

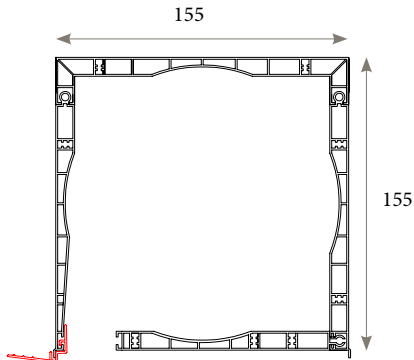

CAJÓN 185

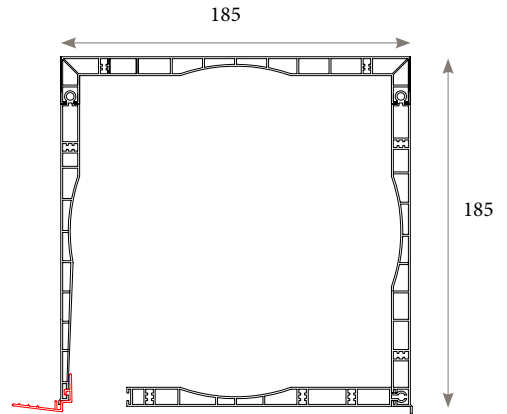

CAJÓN 200

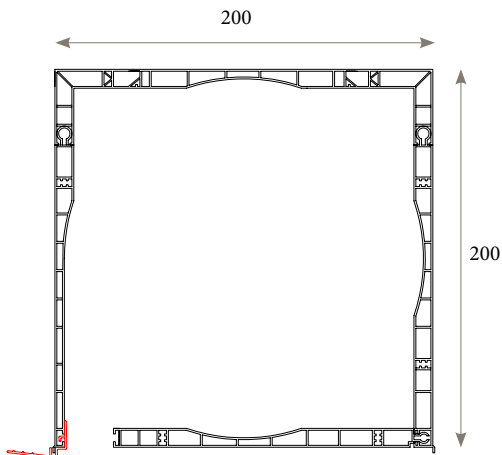

CAJÓN 225

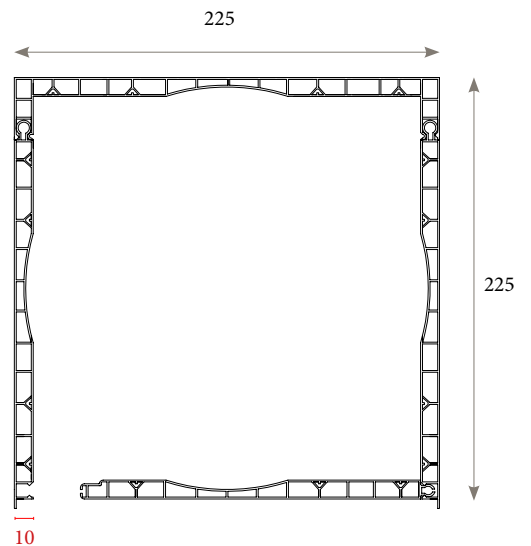

El cajón de 225 no es enrasado, la tapa sobresale 10 mm por la parte exterior de la guía.

Terminales compatibles

TER-GOM

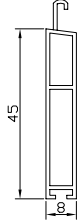

C-45 / C-56 / CP-39

TER-ATB45

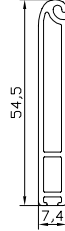

ATB- 45

TER-FL68

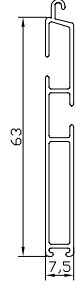

C-45 / C-56 / CP-39 / ATB-39

Complementos

TER-GOM

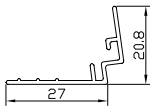

ANG-CUV

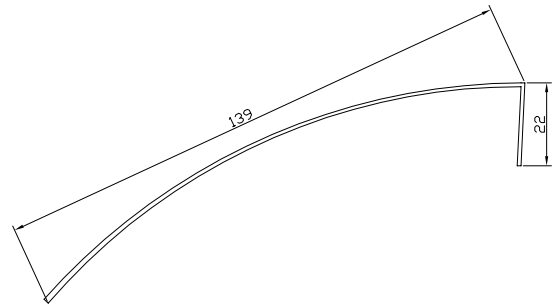

ANG -REG

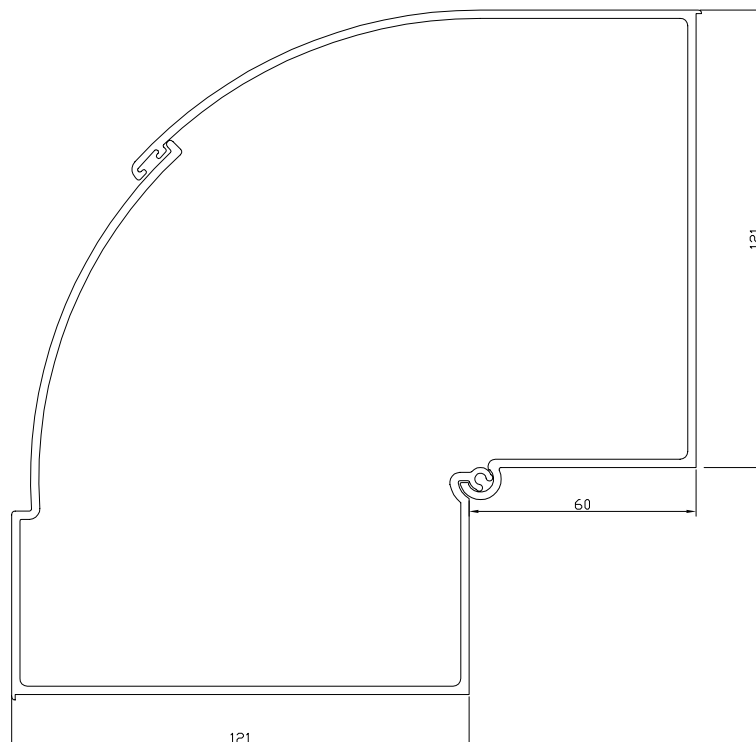

Guías para acoplar en carpintería

GUIA4

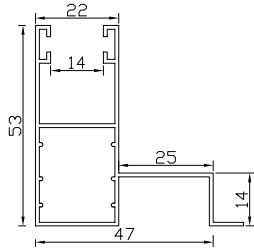

GUIE4

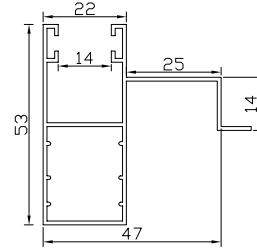

GUIA6

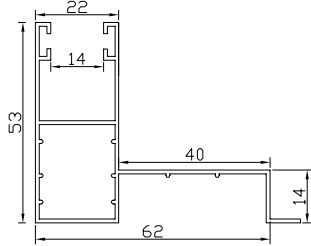

GUIE6

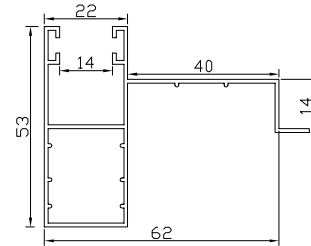

GUIA68

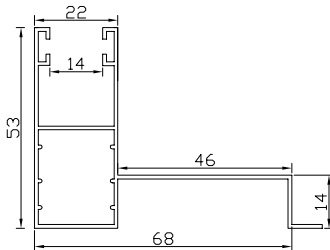

GUIE68

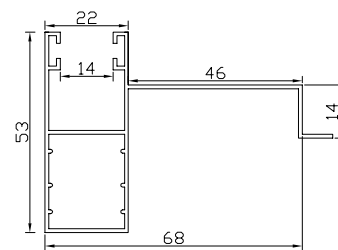

GUIA7

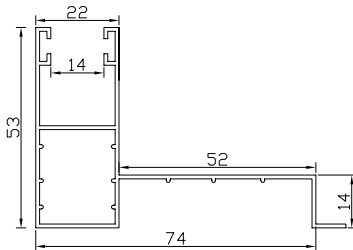

GUIE7

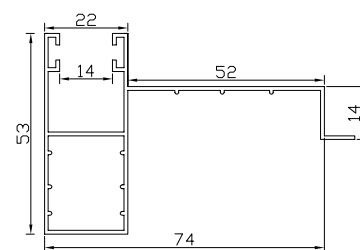

GUIA8

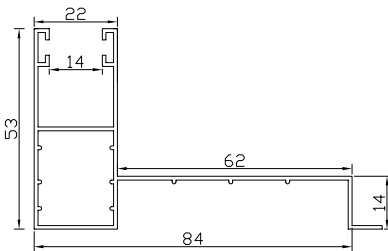

GUIE8

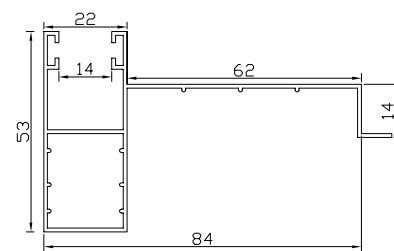

GUIA10

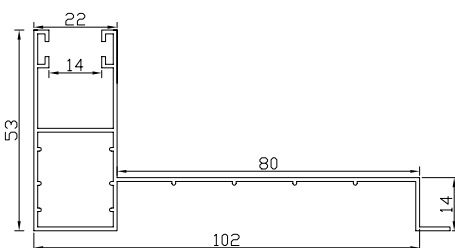

GUIE10

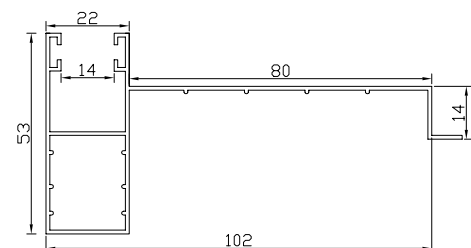

GUIA11

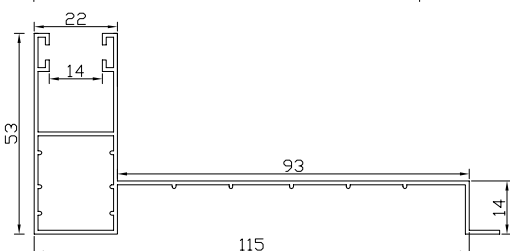

GUIE11

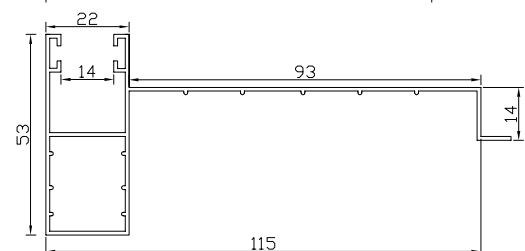

Guías para acoplar en carpintería

GUIH25

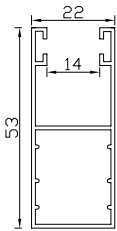

GUIHS

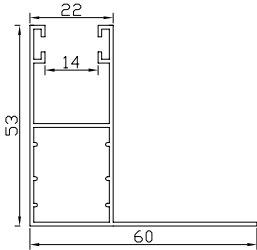

GUIHSL

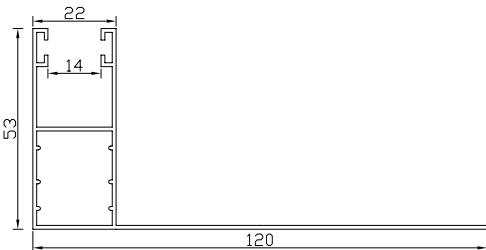

GUIM100

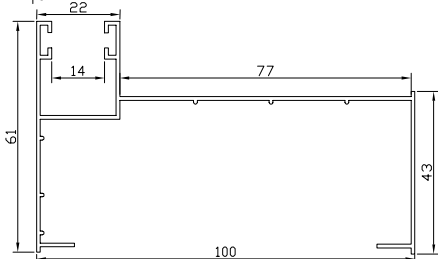

GUIM130

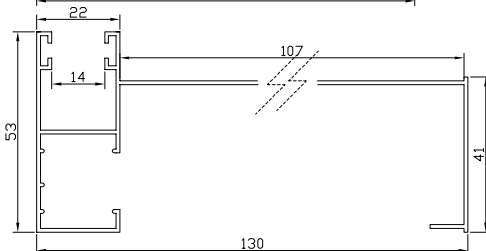

GUIM155

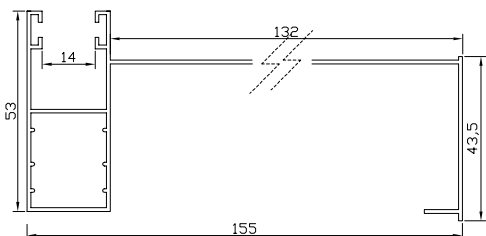

GUIM180

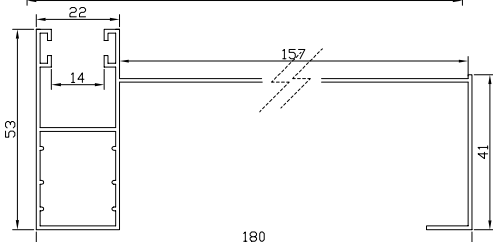

GUIHD

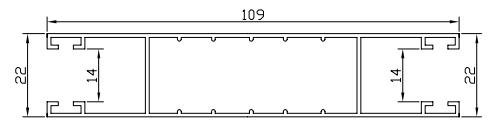

GUIHE

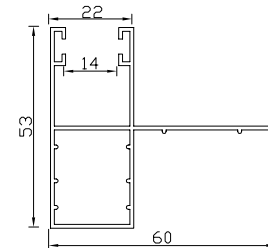

GUIHSE

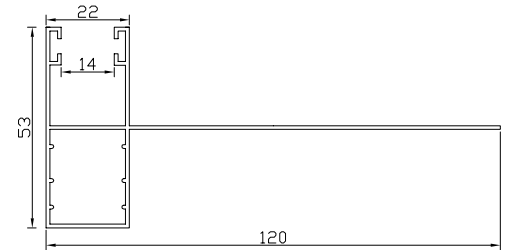

GUIM120

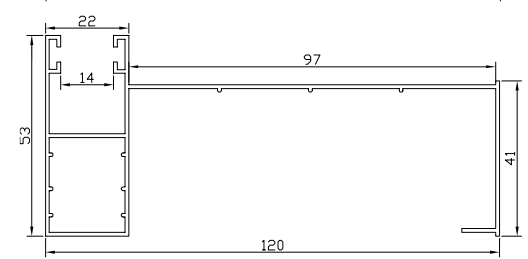

GUIM140

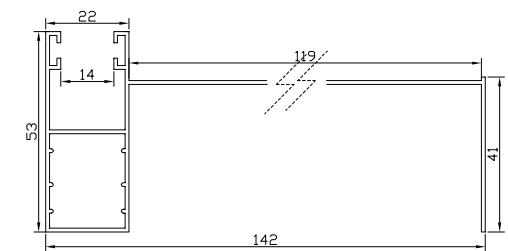

GUIM168

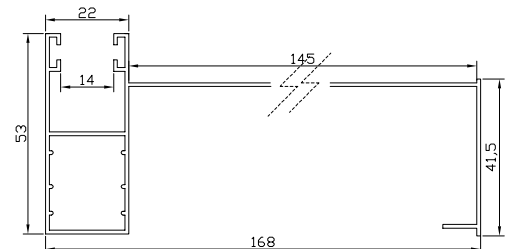

GUIM198

